

ECOFLOW

EcoFlow RIVER 2 Max

User Manual V1.0

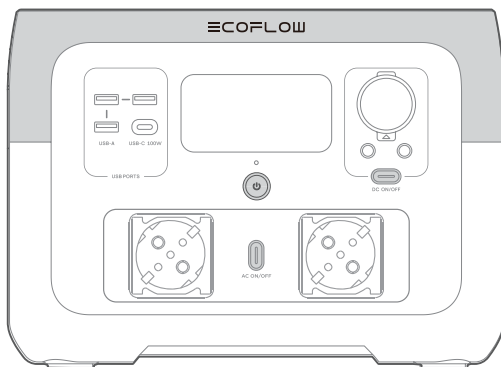

Disclaimer

Read this user manual carefully before using the product to ensure that you completely understand the product and can correctly use it. After reading this user manual, keep it properly for future reference. Improper use of this product may cause serious injury to yourself or others, or cause product damage and property loss. Once you use this product, it is deemed that you understand, approve and accept all the terms and content in this document. EcoFlow is not liable for any loss caused by the user's failure to use the product in compliance with this user manual.

In compliance with laws and regulations, EcoFlow reserves the right to final interpretation of this document and all documents related to the product. This document is subject to changes (updates, revisions, or termination) without prior notice. Please visit EcoFlow's official website to obtain the latest product information.

Content

Specifications	1
Safety Instructions	2
EcoFlow App	3
What's in the Box	3
Product Details	4
Overview	4
LCD Screen	5
Power On/Off	6
Charge Your Devices	6
Charge RIVER 2 Max	7
AC Charging (Grid Charging)	7
Solar Charging	7
Car Charging	8
USB-C Charging	8
Additional Features	9
X-Boost	9
EPS	9
Troubleshooting	10
FAQ	11
Care and Maintenance	11

Specifications

General Information	
Weight	Approximately 6.1kg(13.4lbs)
Dimension	270 x 260 x 196mm(10.6 x 10.2 x 7.7inches)
Capacity	512Wh (20Ah 25.6V≈)
Wi-Fi(2.4G)	Frequency range : 20M: 2412-2472MHz/40M: 2422-2462MHz Maximum output power : 15.67dBm
Bluetooth	Frequency range : 2402-2480MHz Maximum output power : 4.27dBm
Model	EFR610
Input Specifications	
AC Input	220V-240V~50Hz/60Hz, 10A Max
Car Charging Input	12V/24V≈8A, 100W Max
Solar Charging Input	11-50V≈13A, 220W Max
USB-C Input	5/9/12/15/20V≈5A, 100W Max
Output Specifications	
USB-C Output	5/9/12/15/20V≈5A, 100W Max
USB-A Output	5V≈2.4A 12W Max per port
DC Output	12.6V≈10A/3A/3A, 126W Max
AC Output	Pure sine wave, 500W total (1000W Peak) ZA : 230V~50Hz/60Hz* AU : 240V~50Hz/60Hz*
Battery Specifications	
Cell Material	LFP battery
Cycle Life	80%+ capacity after 3000 cycles
Operating Temperature	
Optimal Operating Temperature	20°C~30°C(68°F to 86°F)
Discharge Temperature	-10°C~45°C(14°F to 113°F)
Charge Temperature	0°C~45°C(32°F to 113°F)
Storage Temperature	-10°C~45°C (optimal: 20°C~30°C) 14°F to 113°F (optimal: 68°F to 86°F)

*Do not switch the AC output frequency at will, as it may cause some electrical appliances to stop working.

Safety Instructions

WARNING – When using this product, the following precautions should be adhered to:

Usage

1. Do not use the product near a heat source, such as a fire source or a heating furnace.
2. When using the product, please strictly follow the operating environment temperature specified in this user manual. If the temperature is too high, it may result in a fire or explosion; if the temperature is too low, the product performance may be severely reduced, or the product may cease to work.
3. If this product accidentally catches fire, we recommend that you use the fire extinguishers in the following order: water or water mist, sand, fire blanket, dry powder, and carbon dioxide fire extinguishers.
4. Do not allow this product to come into contact with any liquid. Do not use this product in the rain or high humidity.
5. It is recommended that you use moisture barrier bags in humid environments (for example, places by the sea or waterways) to prevent the product from getting wet.
6. If water is found inside the product, or the product is accidentally dropped into water, it must not be used or turned on again. Please place it in a safe open area, and stay away from it until it is completely dry. Please do not approach the product before it is dry. Please take anti-electric shock measures before touching the product. The dried product should not be used or discarded at will. Please properly dispose of it after contacting Customer Service.
7. Use a dry cloth to clean dirt from the product ports.
8. Do not use this product in an environment with strong static electricity or strong magnetic field.
9. Do not stack any heavy objects on the product.
10. Store the product in a dry and ventilated place.
11. Keep this product out of reach of children and pets.
12. Do not place the battery in a low air pressure environment, as this may cause flammable liquids to leak or even an explosion.
13. Do not disassemble or puncture this product in any way with sharp objects.
14. Do not forcibly block the fan during use.
15. Do not touch the product port with wires or other metal objects to avoid short circuit or other risks.
16. When using or transporting this product, please avoid impact, falls and violent vibrations. In case of a severe impact, stop using this product immediately and turn off the power.
17. Do not use unofficial components or accessories as this will void the warranty. Consult official EcoFlow channels if you need to replace any component or accessory.
18. This product is not recommended for powering medical emergency equipment related to personal safety, including but not limited to medical grade ventilators (hospital CPAP: Continuous Positive Airway Pressure) or artificial lungs (ECMO: Extracorporeal Membrane Oxygenation). The product can be used to power a home ventilator (home CPAP) that

does not have to be continuously monitored by professionals. Please follow your doctor's instructions and consult with the manufacturer for restrictions on the use of the equipment. If it is used for general medical equipment, please be sure to monitor the power status to ensure that the power does not run out.

19. When in use, power supply products will inevitably generate electromagnetic fields, which are likely to affect the normal operation of medical implants or personal medical equipment such as pacemakers, cochlear implants, hearing aids, defibrillators etc. If these types of medical equipment are being used, please contact the manufacturer to inquire about any restrictions on the use of such equipment. These measures are fundamental to ensure a safe distance between the medical implants (for example, pacemakers, cochlear implants, hearing aids, defibrillators, etc.) and this product while in use.
20. When the power supply is connected in the normal mode to a refrigerator, the power supply may be automatically shut down due to the power fluctuation property of the refrigerator. If the refrigerator stores medicines, vaccines or other high-value items, it is highly recommended that you set the AC output to "Never Turn Off" through the EcoFlow app when connecting the power supply product to ensure a continuous power supply. Users should pay attention to the power consumption of the power supply.
21. Do not put fingers or hands into the product.
22. To reduce risk of damage to the electric plug and cord, pull the plug rather than the cord when disconnecting the power pack.
23. Do not operate the power pack with a damaged cord, plug or output cable.
24. To reduce the risk of electric shock, unplug the power pack from the outlet before attempting any instructed servicing.
25. Have servicing performed by a qualified repair person using only identical replacement parts. This will ensure that the safety of the product is maintained.
26. Do not use a battery pack or appliance that is damaged or modified. Damaged or modified batteries may exhibit unpredictable behavior resulting in fire, explosion or risk of injury.
27. Users should not place the product on the floor, or at a height less than 457 mm (18 inches) above the floor, when in a repair facility.
28. For long-term storage, please discharge the product every three months (firstly discharge it to 0%, then recharge it to 60%); the product will not be covered by the warranty if it is not charged or discharged for more than 6 months.

Disposal Guide

1. Whenever possible, please completely discharge the battery of this product before placing the product in the designated battery recycling bin. This product contains batteries. Batteries are hazardous chemicals and should not be disposed of in ordinary trash cans. For details, please follow local laws and regulations on battery recycling and disposal.
2. If the battery cannot be completely discharged due to the failure of the product itself, please do not dispose of the battery directly in the battery recycling bin, and contact a professional battery recycling company for further processing.
3. The battery will not start after over-discharge, please dispose of it.

Grounding Instructions

1. This product must be grounded. If it should malfunction or break down while charging, grounding provides a path of least resistance for electric current to reduce the risk of electric shock. This product is equipped with a power cord that has an equipment grounding conductor and a grounding plug. The plug must be plugged into an outlet that is properly installed and grounded in accordance with all local codes ordinances.
2. Improper connection of the equipment grounding conductor is able to result in a risk of electric shock. Check with a qualified electrician if you are in doubt as to whether the product is properly grounded. Do not modify the plug provided with the product – if it will not fit the outlet, have a proper outlet installed by a qualified electrician.

 **SAVE THESE INSTRUCTIONS**

EcoFlow App



Control, monitor and customize your EcoFlow RIVER 2 Max from afar with the EcoFlow App.

What's in the Box

RIVER 2 Max

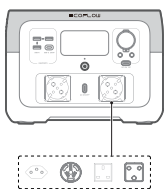

AC Charging Cable

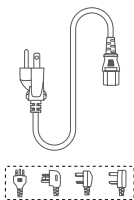

Car Charging Cable

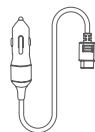

DC5521 Connection Cable

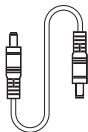

User Manual & Warranty Card

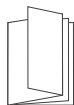

The types of AC sockets and AC charging cables vary in different countries or regions.

Product Details

Overview

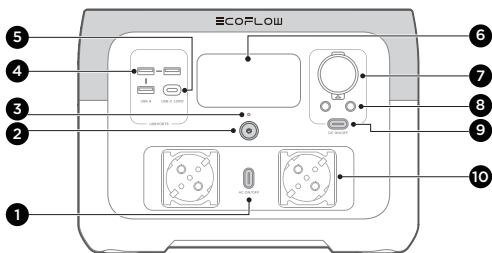

1. AC output switch
2. Main power switch
3. Power indicator
4. USB-A port
5. USB-C port

6. LCD
7. Car charger outlet
8. DC521 output port (x2)
9. DC output switch
10. AC output socket

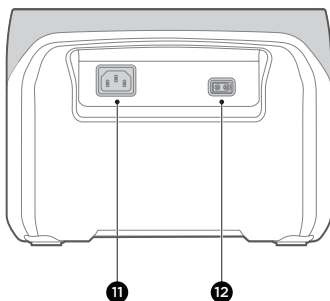

11. X-Stream AC charging input port
12. Solar/Car charging input port

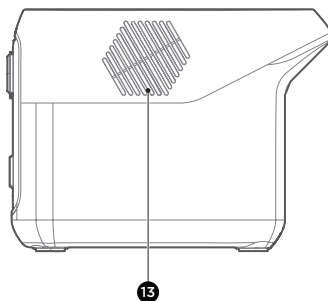

13. Fan (do not block)

LCD Screen

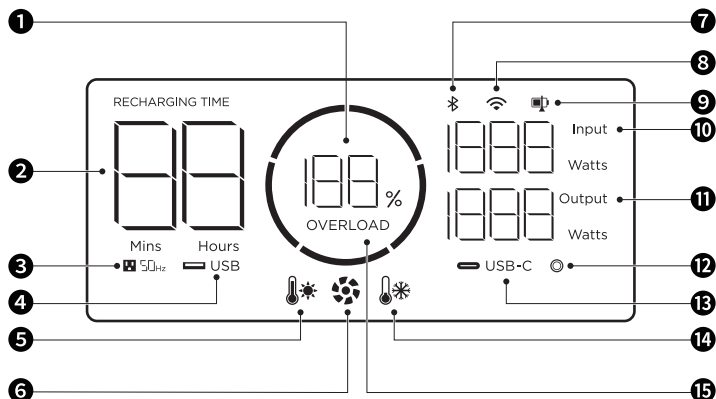

1. Remaining battery

9. Discharge/Recharge level limitation

2. Remaining charge/discharge time

10. Input power

3. AC output

11. Output power

4. USB-A output

12. Car output

5. High temperature warning

13. USB-C output

6. Fan indicator

14. Low Temperature warning

7. Bluetooth connection status

15. Overload Warning

8. Wi-Fi status



Refer to "Troubleshooting" for details.

Power On/Off

Press the main power button once to turn on the product. The LCD screen lights up and the main power indicator flashes white. Press and hold the main power button (for about 3 seconds) to turn off the product, and the LCD screen.

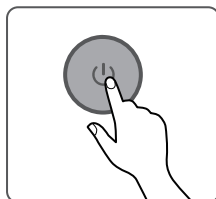
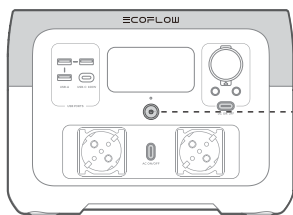

Short press for power-on/
Long press for power-off

1. After the product is turned on, press the main power button once to turn off the LCD screen.
2. If the product is not used for 5 minutes, it will enter hibernation and the LCD screen will turn off.
3. When RIVER 2 Max is charging, it can't be turned off by pressing and holding the main power button unless the charging cable is unplugged first.



Charge Your Devices

The USB-A and USB-C output ports are automatically turned on once the product is turned on. Press the "DC output switch" or "AC output switch" once to turn on their corresponding DC/AC output sockets; press again to turn them off.

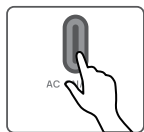

Short press the
power switch

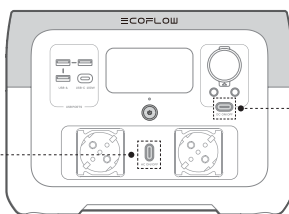

Short press the
power switch



When using the AC output socket, make sure that the sum power of all loaded devices is less than the rated power.

Charge RIVER 2 Max

AC Charging (Grid Charging)

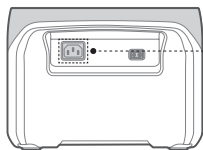

X-Stream fast charging
660W Max
Fully charged in 1 hour



AC charging cable



1. For AC charging, we recommend that you use a power socket with a capacity of more than 10A and ensure that the working current of the socket is constantly greater than 10A.
2. For AC charging, please use the AC charging cable included in the package and plug the cable directly into a wall outlet instead of an extension socket.

Solar Charging

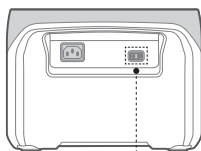

Solar charging cable

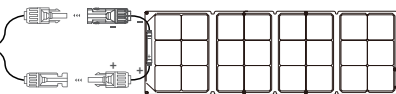

Solar panel

220W Max
Fully charged in
approximate 3 to 6 hours



1. The solar charging cable (MC4-XT60 adapter cable) and the solar panel are supplied separately.
2. When using an EcoFlow solar panel to charge the product, connect them according to the instructions in the user manual.
3. Before connecting the solar panel, ensure that the output voltage of the solar panel is less than 50 V to avoid product damage.

Car Charging

You can recharge the product through the car power outlet. The product supports 12V/24V car chargers and a maximum charging current of 8A.

To avoid failure to start due to insufficient car battery, use the car charger after the vehicle is started. In addition, please make sure that the car charger cable is securely connected to the cigarette lighter.

EcoFlow takes no responsibilities for any loss or damage caused by failure to follow instructions.

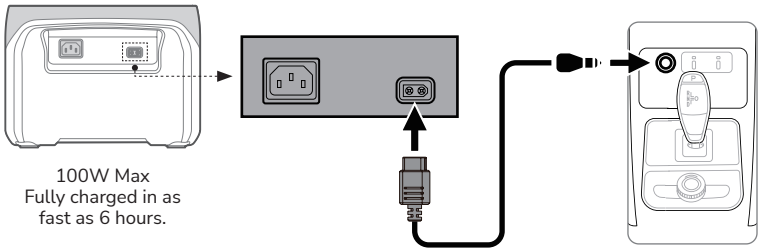

USB-C charging

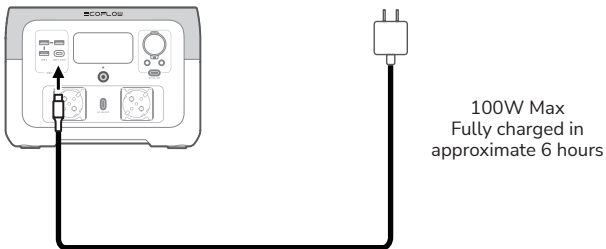

The USB-C charging cable (Type-C plug) and adapter are supplied separately.

Additional Features

X-Boost

The product supports X-Boost. It can power devices rated at up to 1000W without incurring operation failure due to overload protection. Observe the following tips when using the X-Boost feature:

1. The X-Boost feature is not suitable for appliances with voltage protection (such as precise instruments).
2. It is suitable for heating and motor-driven devices. Please conduct your own tests to check whether your devices support X-Boost.

EPS



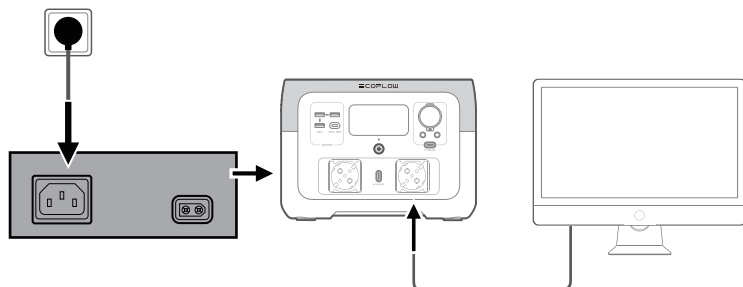





The product supports emergency power supply (EPS). When you connect the grid power to the AC input port of the product through an AC cable, you can power electrical devices through the AC output port (AC power will come from the grid instead of the power station in this situation). In case of a sudden blackout, the product can automatically switch to the battery-powered supply mode within 30ms.



As a basic UPS feature, the EPS does not support 0ms switching. Please do not connect the product to any device that requires 0ms UPS (such as data servers and workstations).

Please test and confirm the compatibility before using the product. We recommend that you power only one device (with maximum power <math><1000\text{W}</math>) at a time and avoid using multiple appliances at the same time to avoid triggering overload protection. EcoFlow takes no responsibilities for any device failure or data loss caused by failure to follow instructions.

Troubleshooting

Indicator	Problem	Solution
 Flashing	Battery discharge low temperature	Normal operation will resume automatically when the battery warms up.
 Flashing	Battery discharge high temperature	Normal operation will resume automatically after the battery cools down.
RECHARGING TIME  Flashing	Battery charging low temperature	Normal operation will resume automatically after the battery temperature is restored to above 3°C.
RECHARGING TIME  Flashing	Battery charging high temperature	Normal operation will resume automatically after the battery cools down.
60Hz  Flashing	AC output low temperature	Normal operation will resume automatically when the product warms up.
60Hz  Flashing	AC output high temperature	Ensure that the air inlet and outlet of the product are unobstructed. Normal operation will resume automatically after the temperature decreases.
 OVERLOAD  OVERLOAD Flashing	USB-C or car charging output overload	Disconnect overloading devices and restart the product to resume normal operation.
60Hz OVERLOAD Flashing	AC output overload	Disconnect overloading devices and restart the product to resume normal operation. The sum power of loaded electrical appliances must not exceed the rated power (for the power limit of electrical appliances in the X-Boost mode, please refer to the X-Boost feature introduction).
RECHARGING TIME OVERLOAD Flashing	Charging overload	Remove the charging cable and normal operation will resume automatically after restart.
 Flashing	Fan blocked	Check whether the fan is blocked by foreign objects.
60Hz Flashing	Communication failure between main control board and AC	Normal operation will resume automatically after restart.



If a warning appears during the use of the product and the warning icon persists after restart, please stop using the product immediately (do not attempt to charge or discharge it). For problems not covered in the preceding table, please consult EcoFlow customer service.

FAQ

1. What battery does the product use?

High-quality LFP battery.

2. What devices can the product's AC output socket power?

The rated power of the product is 500W and the peak power is 1000W. With the X-Boost feature, the product's AC output sockets can power devices rated at 1000W or below.

We recommend that you confirm the power of devices before use, and ensure that the sum power of all loaded devices is less than the rated power.

3. How do I know how long the product can charge my devices?

The charging time is shown on the product's LCD screen, which can be used to estimate the charging time of most appliances with stable power usage.

4. How do I know if the product is charging?

During charging, the remaining charging time is shown on the LCD screen. Meanwhile, the circle indicator around the remaining battery percentage rotates and the input power is shown.

5. Can I take the product on a plane?

No.

6. Can I switch the frequency of the product?

We recommend that you do not switch the frequency in most cases. If you need to switch the AC frequency due to special circumstances, please turn on the AC power, and then press and hold the AC output switch for 10 seconds or use the app to switch frequency.

Care and Maintenance

1. For safety, please do not store the product in an environment temperature higher than add imperial for a long time.
2. For long-term storage, please recharge the product every three months (firstly discharge it to 0%, then recharge it to 60%). The product will not be covered by the warranty if it is not charged or discharged for more than 6 months.
3. If the product has been idle for too long and the battery is severely low, it will enter a deep sleep protection mode. In such case, please charge the product before using it again.

≡COFLOW